

MW-U

Ultrasonic Flow Sensors & Integrator (Calculator)



Features:

- Simply operation
- Integral wall and DIN-rail mounting bracket
- Pulsed or M-Bus output options
- Long life ultrasonic flow meter

Technical Overview

Ultrasonic flow sensors have no moving parts in the volume flow, this makes them almost wear free and noiseless. They measure the flow by using the transit time principle, one ultrasonic signal is launched in the flow direction and one against the flow direction. The flow rate is concluded by the delay time measured, this information is then transmitted to the calculator by the way of electronic pulses.

The calculator uses the latest innovative technology to calculate heat usage from heating systems. With its dynamic measuring cycle even the smallest energy consumptions are reliably collected. The large multifunction display permanently shows the heat consumption total, and by using the button is it possible to scroll through the display to show all data.

Specification:

Meter:	
Nominal flow rate	qp 0.6 to qp 60m ³ /h
Max. static pressure:	
Screwed	16bar
Flanged	25bar
Body materials	Brass
Cable length	1.5m (meter to electronics)
Temperature range	1 to 130°C
Temperature diff	3 to 120K
 Calculator	
Supply	3.6V Lithium battery
Battery life	6 years
Display	Multifunction 8-digit + characters LCD
Cable length	2m (electronics to calculator)
 Sensors & pockets	
Sensor length:	
Meter size 15-32mm	1.5 meters
Meter size 40-100mm	3 meters
Sensor pockets:	
Meter size 15-32mm	45mm
Meter size 40-100mm	105mm
Sensor type	PT500 Matched pair
Pocket thread	½" BSP
 Output	
Output pulse	30Vdc max. @ 20mA
Pulse duration	400ms <T _P <600ms
M-Bus Baud rate	2400
 General	
Ambient range:	
Temperature	5 to 55°C
RH	95% non-condensing
Measurement accuracy	Class 2 (MID Annex MI-004)
Conformity	MID (Annex B + Annex D)
Protection	IP54

* The default location of installation of the flow sensor is in the return. It can be programmed for the meter to be installed in the flow, but this **must** clearly be stated at the time of order.

Part Codes:

MW-U

Heat meter integrator
(build unit with following options)

Output type (add to above code)

- P Pulsed output
- M M-Bus output

Flow sensor (add to above code)

- 4 Qp 0.6m³/h, G¾" (R½") screwed
- 5 Qp 1.5m³/h, G¾" (R½") screwed
- 6 Qp 2.5m³/h, G1" (R¾") screwed
- 7 Qp 3.5m³/h, G1 ¼" (R1") screwed
- 9 Qp 10m³/h, G2" (R1 ½") screwed
- E Qp 10m³/h, DN40 flanged
- F Qp 15m³/h, DN50 flanged
- G Qp 25m³/h, DN65 flanged
- H Qp 40m³/h, DN80 flanged
- J Qp 60m³/h, DN100 flanged

System type (add to above code)

- 4 Heating system
- 5 Cooling system

Replacement items

MW-PKT-1

45mm Stainless steel pockets (pair)

MW-PKT-2

105mm Stainless steel pockets (pair)

MW-PKT-3

140mm Stainless steel pockets (pair)

General Information:

Initial verification

The MW-MD is produced and tested in compliance with the new European measuring instruments directive (MID). According to this directive, devices do no longer carry an initial verification stamp, but rather the year of the device's declaration of conformity (recognizable on the front of the device, for example: M09). The MID controls the use of heat meters up to the moment they are placed on the market resp. their first putting into use. After this, the national regulations for devices subject to legal verification apply within the EU.

The duration of initial verification validity in Germany remains 5 years for heat meters. After this period has expired, the measuring device may no longer be used for billing in commercial use. The regulations resp. validity period may vary in other countries of the EU.

Electro-magnetic interference

The MW-MD fulfils the national and international requirements for interference resistance. To avoid malfunctions due to other interferences, do not install fluorescent lamps, switch cabinets or electric devices such as motors or pumps in the immediate vicinity of the meter (minimum distance 1m). Cables leaving the meter should not be laid parallel to live cables (230V, minimum distance 0.2 m).

Care instructions

Clean plastic surfaces with a damp cloth only. Do not use any scouring or aggressive cleaning agents!

The device is maintenance-free during the service life. Repairs can only be made by the manufacturer.

Declaration of Conformity

Sontay Ltd declares that this product with the number of the EC type examination certificate DE-08-MI004-PTB012 complies with the requirements of the EC directives 2004/22/EC (Measuring instruments directive) and 89/336/EEC (electro-magnetic compatibility).

Installation:

Safety instructions

The installation has to be done by qualified personnel. Read the instructions carefully right up to the end before starting to mount the device.

The current laws and regulations have to be observed, especially EN 1434 part 1+6.

At devices with communication interfaces or mains supply the general technical rules and the correspondent regulations have to be followed.

While demounting flow sensors and temperature sensors care should be taken to ensure that no heating water escapes from the pipe – this can cause burns!

Close valves and release pressure before installation.

Take care of:

- The display must readable at all times, to avoid malfunctions due to other interferences do not install fluorescent lamps, switch cabinets or electric devices such as motors or pumps in the immediate vicinity of the meter (minimum distance 1 m).
- All welding must be finished.
- The ambient temperature must not exceed 55°C.
- The type of temperature sensor must correspond with the calculator.
- The pulse value of the flow sensor must correspond with the one from the calculator.
- The calculator has 7 screwed cable glands for wires with a diameter between 4.2 and 10 mm. Keep unused glands closed.
- Mind the connection order: temperature sensors first, flow sensor afterwards!
- The MW-MD is delivered ready for operation. It does not need any settings or adjustment.

Installation (continued):

Installation heat calculator

Sontay recommends mounting the calculator on the wall. Do not mount the device at the pipe or attach it directly on the flow sensor.

The mounting adapter at the backside of the calculator can be used for DIN-rail mounting or "reverse" for wall mounting.

For wall mounting attach the adapter with at least two screws to the wall and clip the calculator on it.

For rail mounting lift the adapter a little bit, place the calculator on the rail and push the adapter back until it locks.

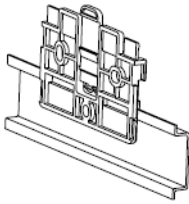

DIN-rail mounting

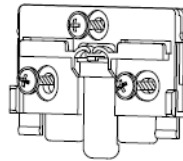

Wall mounting

Connection sensors

The mounting of the temperature sensors should be done symmetrical with direct immersion. If immersion sleeves are used they have to be checked for conformity to MID and have to be marked accordingly. The installation of immersion sleeves has to be done according to DIN EN 1434-2.

- The sensor cables are marked with colours (red = supply, blue = return). Do not buckle, extend or shorten the wire.
- Do only use paired sensors with the same serial number on it.
- Supply and return sensors must be inserted into the immersion sleeves completely.
- Installation points in the flow sensor can be used for symmetrical installation of the temperature sensors.
- Seal temperature sensor after installation to prevent unauthorized demounting (seals included).
- Do not wrap or install wires along hot pipes.

Connection flow sensor

The total length of the wire between flow sensor and calculator should not exceed 2m. Mind the polarity at electronic flow sensors.

Operation test

Check the calculator for any error codes in the display after installation (see Page 5 for error codes). Most of the errors can be deleted by pressing the button.

If the error appears permanently, it will be detected at the next measuring cycle and displayed again. Check whether the volume information is updated and the displayed temperatures correspond to the present ones while the system is running (measuring cycle 2 minutes max.).

When attaching the top cover on the housing pulses on the inputs can possibly be generated. Check readings of the inputs and correct if necessary.

Sealing

Seal the device with the included seals to prevent unauthorized opening.

Maintenance

Repairs or overhaul are only allowed by the manufacturer or companies authorized by the manufacturer.

Outputs:

Pulsed:

The pulse value of the outputs is permanently set and corresponds with the last position of the associated display value.

Example:

Output 1 = energy output
Energy display = XXXXX.XX MWh
Last position = 0.01 MWh = 10 kWh
Output pulse = 10 kWh

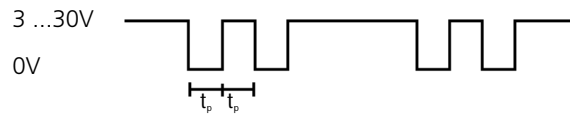

$$400\text{ms} < t_p < 300\text{ms}$$

M-Bus:

The M-Bus interface complies with the norm EN 1434-3 and operates with 2400 baud fixed. It can be set to 300/6900 baud if necessary.

Connections

Inputs:

Temperature sensors
Supply (hottest pipe) 1 & 2
Return (coolest pipe) 3 & 4

Flow sensor pulse 10 & 11 (GND)

If water meters with a potential free reed contact are connected to the inputs the connection can be made in any direction.

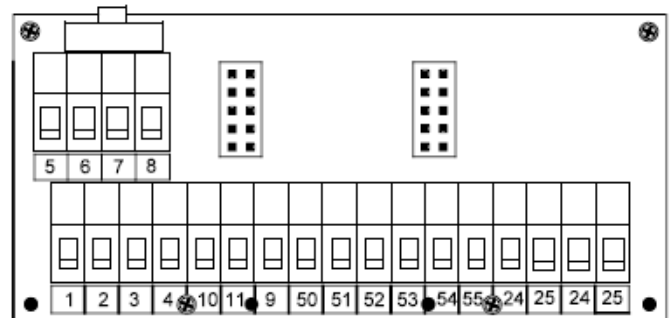

Outputs:





Energy output pulse 52 & 53 (GND)
Volume output pulse 54 & 55 (GND)
Care must be taken when connection is made to a BMS.

M-Bus (M-Bus connections are given twice for incoming and outgoing of the M-Bus wires).

L1 24
L2 25

Error Codes:

The symbols in the table below show the meter's operational status. The status messages only appear in the main display (energy)! The temporary display of the warning triangle can be caused by special operating states and does not always mean that the device is malfunctioning. However, should the symbol be displayed over a longer period of time you should contact Sontay.

Symbol	Status	Event	Error codes show faults detected by MW-MD. If more than one error appears, the sum of the error codes is displayed: Error 1005 = error 1000 and error 5.		
	Flow existent	-			
	Attention	Check for errors	<i>Code</i>	<i>Error</i>	<i>Event</i>
	Data transmission	-	1	Short-circuit return sensor	Check sensors
	Emergency operation	Exchange device	2	Interruption return sensor	"
	External power supply	-	3	Short circuit supply sensor	"
			4	Interruption supply sensor	"
			5	Hardware error	Exchange device
			6	Battery empty/wrong temp sensor	Check
			7	Temp. out of measuring range	Correction of heating system
			100	Emergency operation	Exchange device
			1000	Battery life time exceeded	"
			2000	Initial verification expired	"
			>8000	Internal hardware error	"

Dimensions:

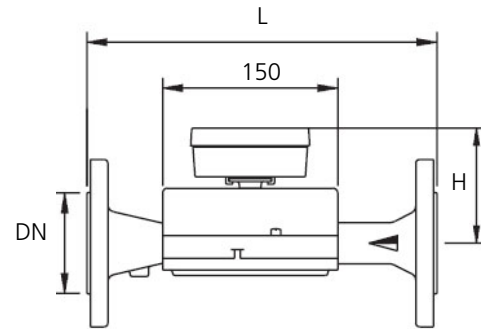
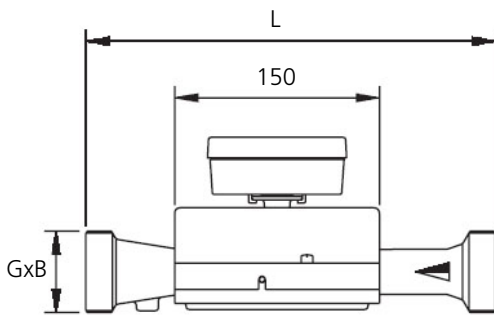
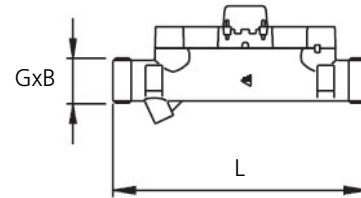
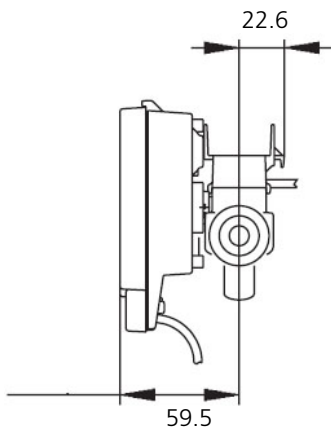
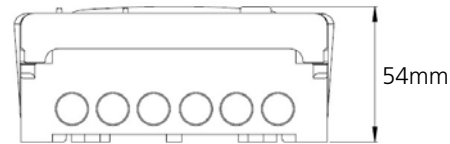
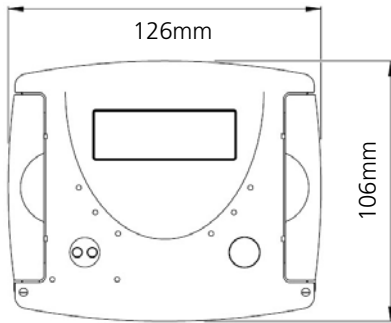

Nominal Flow	qp	m ³ /h	0,6	1	1,5	2,5	3,5	10	15	25	40	60
Nominal Diameter	DN	mm	15	15	15	20	25	40	50	65	80	100
		Inch	½	½	½	¾	1	1 ½	-	-	-	-
Inst. Length without conn.	L	mm	110	110	110	130	260	300	270	300	300	360
Thread meter G x B	D1	Inch	¾	¾	¾	1	1 ¼	2	Flange	Flange	Flange	Flange
Maximum Flow	qi	m ³ /h	1,2	2	3	5	7	20	30	50	80	120
Minimum Flow	qs	l/h	12	20	30	50	35	100	150	250	400	600
Operating Pressure, max.	PN	bar	16	16	16	16	16	16	25	25	25	16/25
Pressure loss at Qn		bar	0,14	0,06	0,13	0,2	0,06	0,12	0,1	0,1	0,16	0,14
Weight		kg	1	1	1	1,5	3	4	8	11	13	22

Display Loops:

Level 1

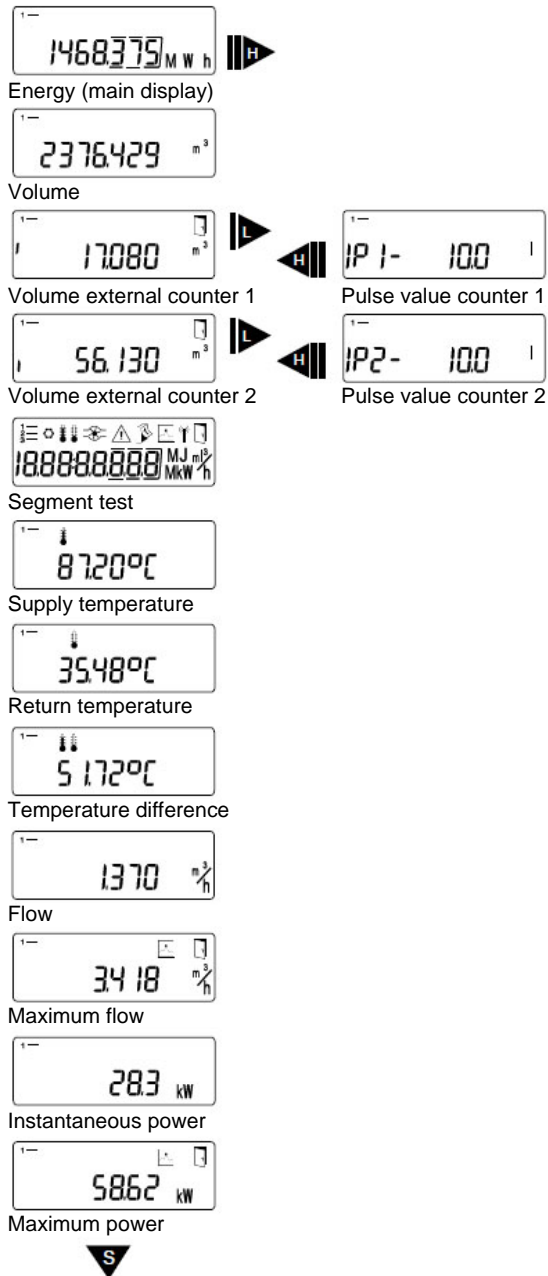

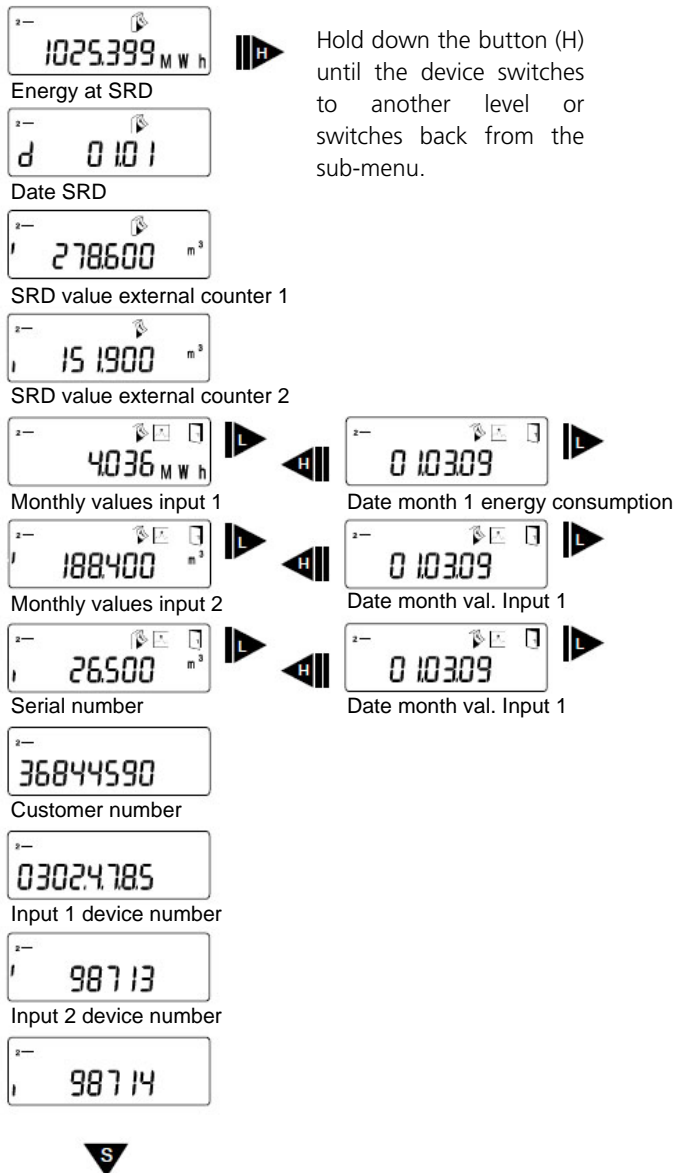

Level 2







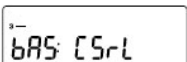
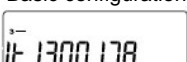
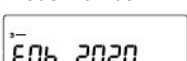
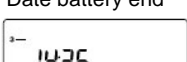
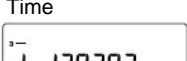
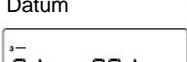
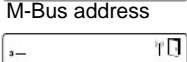
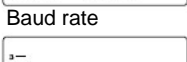
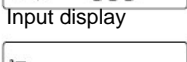
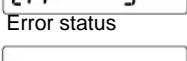

Hold down the button (H) until the device switches to another level or switches back from the sub-menu.

Display Loops (continued)

Level 1

	 Sensor type & installation point
	 Pulse value
	 Basic configuration
	 Model number
	 Date battery end
	 Time
	 Datum
	 M-Bus address
	 Baud rate
	 Input display
	 Error status
	 Software version

  1st monthly value heat energy	
  1st monthly value input 1	
  1st monthly value input 2	

Legend

-  Press the button briefly (S) to switch through the display from top to bottom. When you have reached the last menu item the device automatically jumps back to the menu item at the top (loop).

-  Press the button for about 2 seconds (L), wait for the door symbol to appear (upper right corner of the display) and then release the button. The menu is then updated resp. switches to the sub-menu.

-  Hold down the button (H) until the device switches to another level or switches back from the sub-menu.