

VA-08

8Nm On/Off, Raise/Lower & Modulating Actuators



Features:

- Maintenance-free
- Position indication
- Reversible rotation
- Mechanically set rotation limits
- Manual override

Technical Overview

The VA-08 range of actuators require either a 24Vac/dc or 230Vac supply depending on version ordered. They are available to accept either an on/off/floating (raise/lower) or modulating control signal input. They also have auxiliary switch option.

The direction of rotation can be reversed by a simple selector switch. The actuator is overload-proof, and requires no limit switches and automatically stops when the end stop is reached.

Specification:

Part Codes:

Power supply:	
VA-x-24	19-29Vac/dc (24V nominal)
VA-08A-230	85-265Vac (230V nominal)
Max. power consumption:	
VA-x-24	
	Running 2W
	Stopped 1W
VA-08A-230	
	Running 1.5W
	Stopped 1W
Connection	Via 1m flying lead (halogen free)
Angle of rotation	0° - 95°
Running time	
VA-08A -x	60 to 120s / 90°
VA-08M -24	<150s / 90°
Damper coupling:	
Square	8-12mm
Round	8-16mm
Damper size	Up to approx. 1.6m ²
Protection	IP54 (cable downwards)
Aux. switch rating	SPDT 5(2.5)A @250Vac
Service life	>60000 cycles (0°-95°-0°)
Ambient:	
Temperature	-20 to +50°C
RH	5 to 95% RH
Protection class	
VA-x-24	III
VA-08A-230	II
Conformity	CE
Country of origin	Germany

VA-08A-24	24Vac/dc 8Nm on/off or Floating actuator
VA-08A-245	24Vac/dc 8Nm on/off or Floating actuator with auxiliary switch
VA-08A-230	230Vac 8Nm on/off or Floating actuator
VA-08A-230S	230Vac 8Nm on/off or Floating actuator with auxiliary switch
VA-08M-24	24Vac/dc 10Nm Modulating actuator
VA-08M-24S	24Vac/dc 10Nm Modulating actuator with auxiliary switch



24Vac/dc versions

The products referred to in this data sheet meet the requirements of EU Directive 2004/108/EC

230Vac versions

The products referred to in this data sheet meet the requirements of EU 2004/108/EC and 2006/95/EC

Installation:

1. Ensure that all power is disconnected before carrying out any work on the damper actuator.
2. Attach the actuator to the damper spindle, finger tighten the nuts on the V-clamp.
3. Fix the anti-rotation device to the back of the actuator. This is supplied connected to the back of the housing, to release simply buckle.
4. Move the damper to the closed position. Using the manual override push button, turn the clamp until the actuator is in the correct position and tighten the V-clamp.
5. If the damper has no fixed stops of its own, the angle of rotation / working range can be adjusted mechanically by re-positioning the adjustable stops.
6. Terminate the cores of the flying lead as required and ensure that the voltage is within the specified tolerances.

Operating Modes & Connections:

2-Point

Through connecting the power supply to BU+BN (1+2) and the direction of rotation switch on position "R" moves the actuator to position 1. Is also BK (1+2+3) connected to the power supply the actuator is moving to position 0.

3-point

Through connecting the power supply to BU+BN (1+2) and the direction of rotation switch on position "R" moves the actuator to position 1. If the power supply is interrupted the actuator maintains its current position. Is also BU+BK (1+3) connected to the power supply the actuator is moving in direction 0

2-Point

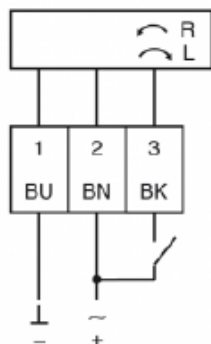

3-Point

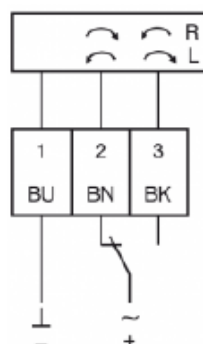

Rotary direction switch

R= clockwise
Adp= adaption
L= counter clockwise



Operating Modes & Connections (continued):

Modulating

Through connecting the power supply to BU+BN (1+2) and a reference signal Y to BK (3) of 0(2)...10Vdc, moves the actuator to its specified position. The actual damper position 0...100% is a feedback signal U for example to share the signal with other actuators.

Mode-switch

Mode-switch with five positions at the housing

- Rotary direction right 2-10V
- Rotary direction right 0-10V
- Adp = Adaption
- Rotary direction left 2-10V
- Rotary direction left 0-10V
-

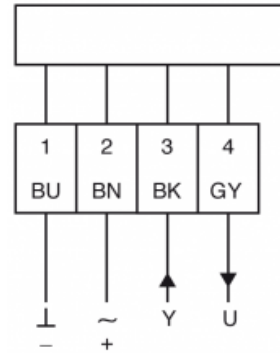
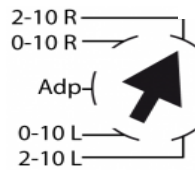

Adjustment of auxiliary switches

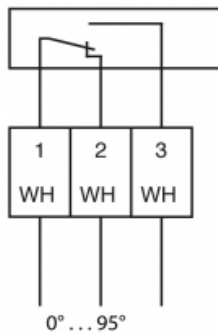

Dimensions:

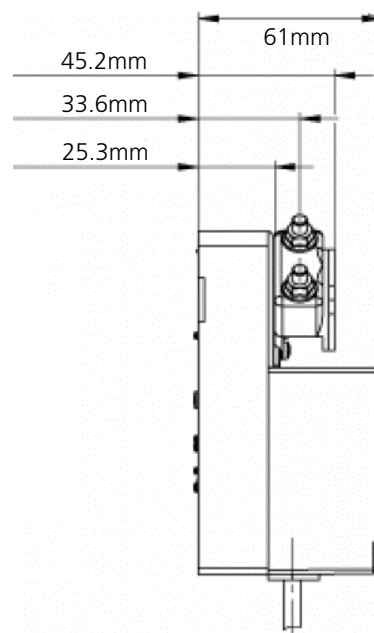
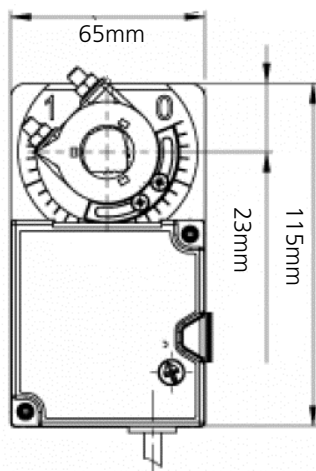

Whilst every effort has been made to ensure the accuracy of this specification, Sontay cannot accept responsibility for damage, injury, loss or expense from errors or omissions. In the interest of technical improvement, this specification may be altered without notice.